

MR-2900/MR-2920

Intelligent Addressable Fire Alarm Control Panels



MR-2900 Fire Alarm Control Panel

Description

The MR-2900 fire alarm system control unit is the heart of a sophisticated microprocessor-based fire alarm system. With the capability of networking, the MR-2900 is ideally suited for the varied needs of residential, commercial, industrial, and institutional applications. The MR-2900 provides both conventional and addressable input circuits. It has the ability to 'software' configure conventional input circuits for alarm or supervisory function, and operation with contact devices only, smoke detectors only, or both smoke detectors and contact devices with the system having the ability to differentiate between smoke detector and contact device activation. Addressable input circuits using addressable analog detectors, monitoring modules, and control modules are available using addressable input circuit modules.

The MR-2900 has capacity for up to 24 input circuits, four general purpose Form C relays, and eight polarity reversing notification appliance (bell) circuits. System operated relays are available for alarm, trouble, and supervisory indication.

Input circuit modules are available for conventional circuits and addressable circuits. The MR-2908 and MR-2928 conventional input circuit modules each have eight Class B circuits which can be wired for Class A by utilizing two circuits. The MR-2938 conventional input circuit module supports four Style D (Class A) smoke detector circuits. The MR-2929 addressable input circuit module supports eight Style 4 (Class B) circuits or four Style 6 (Class A) circuits.

The first eight circuits of the MR-2900 control unit are reserved for conventional circuits while the remaining 16 circuits can be used for addressable or conventional input circuits in groups of eight.

Features

- Listed to UL 864, 9th edition
- Sophisticated capabilities yet simple to operate
- Conventional and addressable detection circuits
- Adjustable sensitivity
- Day/night sensitivity
- One-person system test capability
- Totally software driven
- Field programmable via PC
- Passcode protection
- History log ≈ 1400 events
- System alarm, supervisory, and trouble relays
- Alarm, supervisory, and trouble LEDs for each zone
- Custom labels per zone
- Remote alarm and trouble annunciation
- Remote detector test capability
- LCD supertwist 80 character (4 x 20) backlit display
- Sprinkler supervision
- Ground fault indication by supervised circuit
- Software definable conventional input circuits
- Conventional input circuits Style B (Class B) or Style D (Class A)
- Addressable input circuits Style 4 (Class B) or Style 6 (Class A)
- Input circuits programmable for N.O. or N.C. contacts
- Style Y (Class B) or Style Z (Class A) notification appliance (bell) circuits
- Power limited circuits
- DCLR network communication option
- Optional integrated strip printer
- 'Hot Key' system controls
- Display of real time
- Signal silence inhibit
- Signal time limit cut-out
- Boolean Logic
- Supports Acclimate and Pinnacle Smoke Detectors
- MR-2920 provides an optional panel mounted printer

With the addition of MR-2910 Series network boards, MR-2900 control units can be networked together to provide additional input circuits, visual zones, programmable notification appliance (bell) circuits, and relays. Up to 254 control and annunciator units can be networked together. The network is a DCLR (Data Communications Link, Redundant) configuration loop.

Each annunciator can contain up to 576 LEDs (192 zones) for annunciation purposes, an LCD display for messages, and 16 predefined switch inputs for control functions.



S6619



S6619



7165-1656:100



352-03-E



APPROVED

Main Control Unit

The system controls and visual indicators are contained on the main circuit board, which also contains the system processor, programming port, printer port and non-volatile memory for storage of system programming. Operating software is installed on the main board for purposes such as function relay operation, zone LED annunciation, and custom zone and devices messages.

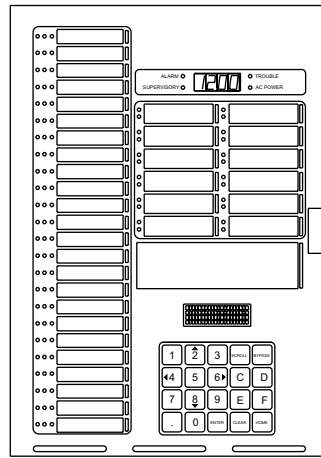

Main Control Unit

System controls consist of 12 system switches ('Hot Keys') and a 20 position alphanumeric keypad. The 12 system switches are factory and user defined for operations such as alarm acknowledge, notification appliance (bell) silence, and system reset. The 20 position keypad is used for technical functions, system/detector maintenance, history recall, device and circuit disarming, and for manual operation of addressable output modules, relay modules, and notification appliance (bell) circuits.

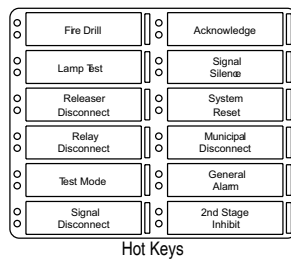

Hot Keys

Display

The visual display consists of a series of LEDs for common system indication of power, alarm, supervisory, and trouble. An LED clock display is provided to display real time. The flashing colon of the clock provides visual indication of system processor operation.

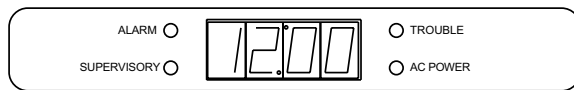

System Display

An 80 character supertwist LCD alphanumeric display is provided for display of device addresses and identification, zone identification for conventional input circuits, and for display of history files, first /last device in alarm, custom messages, etc. The keypad can be used to scroll through the display. The keypad and the display are also used for maintenance functions, such as testing.

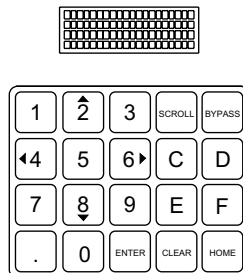

Keypad and LCD Display

Individual LEDs are provided to display alarm, supervisory and trouble conditions by zone. The control unit contains 24 sets of zone indicating LEDs. The LEDs will flash on status change and go to steady when acknowledged.

The trouble LEDs will indicate both open circuit and ground fault. The LCD display is used to determine the exact nature of the trouble.

Addressable input circuits can be configured to map individual detectors or groups of detectors to turn-on specific zone indicating lamps. Addressable devices are also indicated on the LCD display, which provides device number, addressable input circuit number, and a custom message.

Input Circuits

The MR-2900 motherboard uses up to three input circuit modules. Each input circuit module supports either eight Class B or four Class A circuits. Three versions are available, models MR-2928 and MR-2938 for conventional devices and model MR-2929 for addressable devices. The location for the first input module will accommodate only a conventional input circuit module. The remaining two locations can be used for conventional or addressable input modules.

Conventional circuits are individually software definable for contact devices only, smoke detectors only, or combination of smoke detector and contact devices. Circuits defined for smoke detector and contact devices are able to differentiate between smoke detector operation and contact device operation, which permits combining contacts and smoke detectors on one common circuit. The circuits are further definable for alarm or supervisory. Alarm and supervisory operation provides visual indication on separate LEDs. Input circuits programmed for contact devices can be further defined for use with N.O. or N.C. contacts.

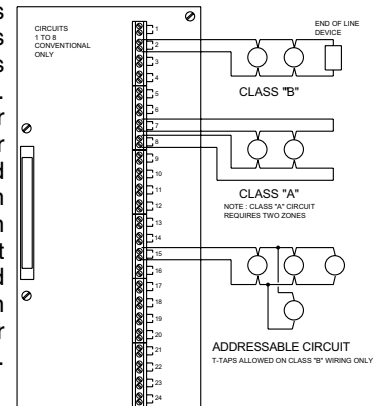

Input Circuits

The Conventional input circuits will display alarm, supervisory and trouble condition by zone. Each indicating zone will have a separate LED for alarm, supervisory, and trouble condition. The circuits can be for Style B (Class B) or Style D (Class A) wiring. When Style D wiring is required, two circuits are required for each Style D circuit.

Up to 99 addressable detectors and up to 99 addressable control/monitoring modules may be connected to one circuit for a total of 198 addressable devices per addressable circuit. Addressable monitoring modules can be programmed for alarm or supervisory functions. Control modules can be configured for dry contact or supervised output.

Ground faults are indicated by input circuit.

Output Circuits

Field connections are terminated at the terminal board, which in addition to terminal blocks contains a portion of the circuitry for output circuits and relays. Output circuit components are separated from the main board for ease of service and electrical separation from the main board.

The control unit includes eight Class B or four Class A supervised polarity reversing notification appliance (bell) circuits, four general purpose Form C relays, three system Form C relays, and two auxiliary power outputs. The notification appliance (bell) circuits are rated at 1.5 A @ 24 VDC.

Note: The control unit is limited to 8 A total notification appliance (bell) current and maximum system loading and stand-by battery power must be considered when determining actual notification appliance (bell) loading.

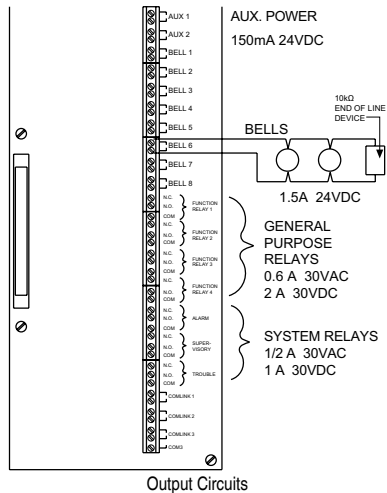

Output Circuits

The Notification appliance circuits (bell) require a 10k ohm end-of-line resistor for Class B supervision. Notification appliance (bell) circuits are supervised for opens, shorts, and ground faults, with indication by circuit.

General purpose Form C relay operation is program defined. The relays are rated 0.6 A @ 30 VAC, 1 A @ 30 VDC. The system defined Form C relays are for common alarm, supervisory, and trouble indication. These relays are rated at 1/2 A @ 30 VAC, 1A @ 30 VDC.

The operation of the general purpose relays and the notification appliance (bell) circuits are totally program defined. It is possible to program the activation of relays and notification appliances (bells) in response to any zone, group of zones, device, and group of devices, and to inhibit the operation for a specifiable period of time. The two auxiliary power outputs are rated for 24 VDC @ 150 mA. They are supervised for shorts only. Power outputs operate independently from each other.

Communication Ports

The control unit has 6 communication ports available:

- Port #1 - network (proprietary)
- Port #2 - network (proprietary)
- Port #3 - general purpose (RS-232/opto-coupled/RS-485)
- Port #4 - service terminal (RS-232)
- Port #5 - printer interface (IBM/Centronics)
- Port #6 - printer interface (RS-232)

The network ports allow for the networking of up to 254 units (any mix of control units and annunciators). The network is a DCLR loop layout. In a network configuration, one control unit will be defined as the 'master control unit' for the entire system.

Compatible Products

The system service terminal port will permit the downloading and uploading of software such as device messages and I/O functions.

The system printer port is a parallel port providing an interface to any standard printer. It can be used for system commissioning and testing by producing a printed log of received events. This can then be checked against a log of tests performed to confirm correct operation.

The serial printer port is for connection to the optional factory installed serial printer.

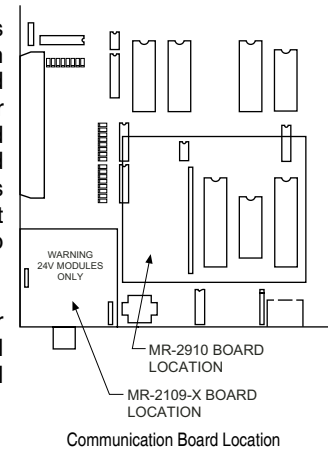

The general-purpose port is available for remote annunciation of system alarm and system trouble. The operation of this port is software defined and requires the use of a MR- 2109-X communication board.

Power Supply

Power Wiring Reference

The MR-2905M power supply is rated at 10 A unregulated, providing the system with primary DC power. The power supply is complete with battery charger rated at 2 A and includes battery supervisory circuitry.

The power supply is located in a separate compartment in the control unit back box with space available for up to 12 Ah batteries. Battery sizes of 24 Ah and 38 Ah are available using a separate battery cabinet, mounted adjacent to the control unit cabinet.

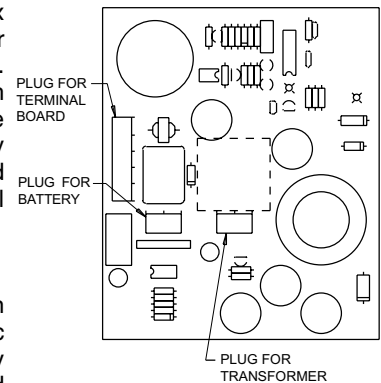

Battery supervision uses true dynamic supervision circuitry to simulate a load condition approximately every 90 seconds to ensure that the battery is operationally functional.

A second compartment adjacent to the power supply compartment is provided for 120V/240V terminations.

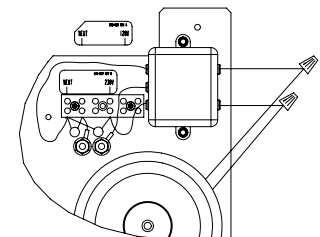

AC Terminations Reference

Enclosure

The enclosure for the MR-2900 and the MR-2920 consists of a back box complete with power supply, an inner door assembly complete with main board, and an outer door assembly. The back box and door assemblies are fabricated from 0.060 inch (1.5 mm) steel. The front door includes a tempered glass window, hinge, and lock assembly. Knockouts are provided in the back box for conduit entry. Refer to page 7 for additional enclosure information.

Hardware Options

Dialer Option MR-2900-DACT provides a digital alarm communicating transmitter (DACT) that will communicate alarm, supervisory, and trouble conditions to a Central Station using Contact ID, SIA, or 10/20 BPS communications formats. Three telephone numbers are supported and test transmissions are fully programmable including selectable power fail delay reporting.

City Connection Option MR-2900-CITY supervises alarm, supervisory, and trouble conditions using the external annunciator bus communications. Outputs are selectable for Remote Station (Reverse Polarity or Municipal Master Box Local Energy Coil) operation.

An Isolator Module is included with the Dialer Module or City Module. It allows serial annunciators to be used with the Dialer Module or City Module options.

Note: Use of either the Dialer module or City Module requires an MR-2109-3 Driver Module located in the panel.

Peer To Peer Networking

The basic control unit can be networked to other control units and annunciators to provide additional relays, notification appliances (bells) and LEDs. Up to 254 control units and annunciators can be placed on the network. The network is a DCLR loop layout. One control unit is designated the 'master control unit' for the network. Diagnostics can be done at any control unit. Programming of an individual control unit is done at that unit. Each control unit operates independently if communications with the master control unit are lost.

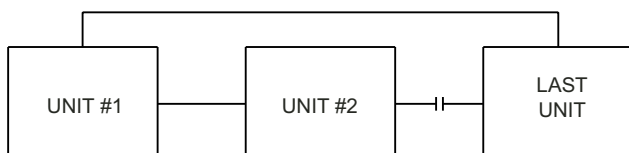

DCLR Loop Layout

Field Programming

The system program can be downloaded, in the field, from a computer via the service terminal port. The control unit operational database is downloaded from a computer.

There is provision for uploading the database from the control unit to the computer.

All information is stored in non-volatile flash memory and E2PROM.

Optional Panel Mounted Printer

The MR-2920 control unit with printer is a complete MR 2900 control unit that includes a panel mounted 20 column thermal strip event printer to capture control unit events. If the MR-2920 is the master control unit for a network, it will print events that occur at all control units.

Printer mounting is in a separate compartment to the left of the fire alarm control panel.

Printer Details (refer to page 6 for specifications):

The Control switch provides ON, OFF, paper feed, and manual test mode.

Multi-color status LED provides Green for power-on, Green/Yellow for paper low, and Yellow for paper out.

Exposed paper area is 2-3/8" x 4" (60 mm x 102 mm). Paper-out is supervised.

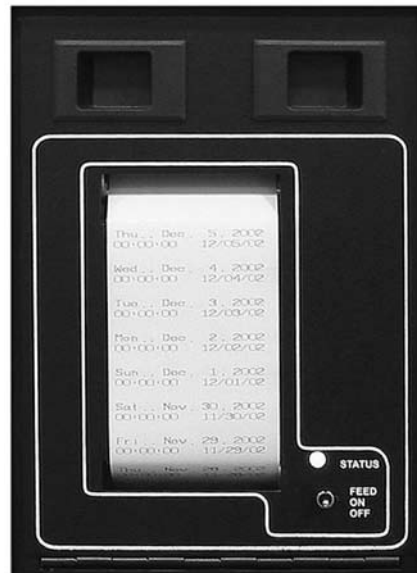

MR-2920 Panel Mount Printer

Specifications

Input Power		
AC	300 VA nominal; 2.5 A @ 120 VAC, 60 Hz; or 1.25 A @ 240 VAC, 50 Hz	
DC	100 mA nominal @ 24 VDC on standby operation	
Environmental		
Temperature Range	32° to 120°F (0° to 49° C)	
Humidity Range	Up to 93% RH, non-condensing @ 90° F (32° C) maximum	
Input Circuits		
	Conventional	Addressable
Voltage	20-28 VDC	20-28 VDC
Supervisory current		
Contact devices	10 mA	–
Smoke detectors	10 mA	–
Alarm current		
Contact devices	10 mA	–
Smoke detectors	80 mA max.	–
Max. number of devices	25 (smoke detectors)	99 detectors/99 modules
Compatible devices	Consult Manual	MRI series
End-of-line device		
Contact devices	470 Ω resistor, T301-9020	–
Smoke detectors	Use Model T301-9017 or 3.9 kΩ resistor	–
Total line resistance	200 Ω	40 Ω
Total line capacitance	100 μF	0.5 μF
Maximum line length	3,050 m (10,000 ft) (18 AWG, 0.82 mm ²)	3,050 m (10,000 ft) (12 AWG, 3.31 mm ²)
T-tapping	No	Style 4 (Class B) only

Circuit Description	Style (NFPA-72)	Class	No. Of Devices	End Of Line
Conventional	D	A	25 smoke	no
Input Circuit	B	B	25 smoke	yes
Addressable Input Circuit	6	A	99 detectors & 99 modules	no
	4	B		no
Signaling (Output) Circuit	Y	B	1.5 A/circuit	yes
	Z	A		no
Network	7	DCLR	254 units	–

Notification Appliance (Bell) Circuits (8 Style Y Or 4 Style Z)	
Supervisory current	1 mA
Alarm current	1.5 A
Voltage	24 VDC (unfiltered)
End-of-line device	10 kΩ resistor (Style Y only)

Note: Control unit is limited to 8 A total notification appliance (bell) current.

Relays and Auxiliary Outputs	
System Relays (3)	1/2 A @ 30 VAC, 1A @ 30 VDC
General Purpose Relays (4)	0.6 A @ 30 VAC, 2 A @ 30 VDC
Auxiliary Power Outputs (2)	24 VDC @ 150 mA

Battery Capacity		
Standard	4.0 Ah	
Optional	in cabinet	10 Ah, 12 Ah
	in external battery cabinet	24 Ah, 38 Ah

Communication Boards			
Model	Wire Type	Wire Gauge*	Distance
MR-2109-2	twisted pair	14-22 AWG	10 km (6.2 miles)
MR-2109-3 (for comms. to MR-2614)	twisted pair	14-22 AWG	
MR-2109-4	twisted pair	14-22 AWG	10-20 m (33-66 ft)

(RS-232; for comms. to GRID)

Network Boards (Standby = Alarm = 30 Ma)				
	Port 1		Port 2	
	Protocol	Distance	Protocol	Distance
MR-2910	Std. (1)	10 km (6.2 mi)	Std. (1)	10 km (6.2 mi)
MR-2910-R1	RS-232 (2)	20 m (66 ft)	Std. (1)	10 km (6.2 mi)
MR-2910-R2	Std. (1)	10 km (6.2 mi)	RS-232 (2)	20 m (66 ft)
MR-2910-R12	RS-232 (2)	20 m (66 ft)	RS-232 (2)	20 m (66 ft)

(1) Standard ... twisted pair 14-22 AWG*

(2) RS-232 ... for connection to modem

* Metric equivalent = 0.32 mm² to 0.081 mm²

Dialer And City Connect Module	
Module	Current
Dialer Module	40 mA standby, 65 mA dialing
City Module	20 mA standby, 65 mA alarm
Isolator Module	10 mA

Specifications (continued)

MR-2920 Panel Mounted Printer, Electrical Specifications	
Input Voltage	19 to 33 VDC, from control panel; Standby = 125 mA @ 24 VDC; Printing = 800 mA @ 24 VDC
Communications	RS-232, 9600 baud
MR-2920 Panel Mounted Printer, Print Specifications	
Print Format	Fixed thermal printhead producing black characters
Characters	11 x 28 dot matrix; alarm information printed in bold
Paper Format	40 columns; 6 lines per inch; 20 lines visible; paper is wound onto top take up reel, paper can be manually unwound from take-up reel and rewound using Feed switch
Speed	Paper speed = 1.33 in/sec (34 mm/sec) maximum; print speed = 312 cps
Sound Output	55 dB maximum, cabinet door open
Thermal Paper	2.35" wide, 160 ft long (60 mm x 49 m)

Compatible Intelligent Addressable Devices

Compatible Intelligent Addressable Devices Reference Information

Model	Description
MRI-1251B	Intelligent Ionization Detector
MRI-2251B	Intelligent Photoelectric Detector
MRI-2251TB	Intelligent Photoelectric Detector with 135°F Fixed Temperature Heat Detector
MRI-2251TMB	Intelligent Acclimate™ Photo Thermal Multicriteria Smoke Detector
MRI-5251B	Intelligent Heat Detector, 135°F fixed temperature
MRI-5251RB	Intelligent Heat Detector, 135°F fixed temperature with rate-of-rise detection
MRI-5251H	Intelligent High Temperature Heat Detector, 190°F fixed temperature
7251	Intelligent Pinnacle™ Ultra High Sensitivity Laser Smoke Detector
FTX-P1	Intelligent Filtrex™ Photoelectric smoke detector
DNR	Intelligent InnovairFlex Photoelectric Non-Relay Duct Smoke Detector Housing
BEAM200	Intelligent beam smoke detector with 8" reflector
BEAM200S	Intelligent beam smoke detector with 8" reflector and integral sensitivity test
MRM-701ADU	Intelligent Addressable Key Resettable Single Action Manual Station
MRM-710ADU	Intelligent Addressable Key Resettable Dual Action Manual Station
MCP5A-RP01FG-K013-01	Intelligent Addressable Call Point (EN-54 LPCB Certified Only)
MRI-M500M	Intelligent Addressable Monitor Module
MRI-M500R	Intelligent Addressable Relay Module
MRI-M500S	Intelligent Addressable Supervised Control Module
MRI-M501M	Intelligent Addressable Mini Monitor Module
MRI-M502M	Intelligent Zone Interface Module
MRI-M500X	Isolator Module
MRI-M500DM	Intelligent Addressable Dual Input Monitor Module
CR-6	Intelligent Addressable Six Relay Control Module
SC-6	Intelligent Addressable Six Supervised Control Module
CZ-6	Intelligent Addressable Six Conventional Zone Interface Module
IM-10	Intelligent Addressable Ten Input Monitor Module

MR-2900 Back Box Dimensions

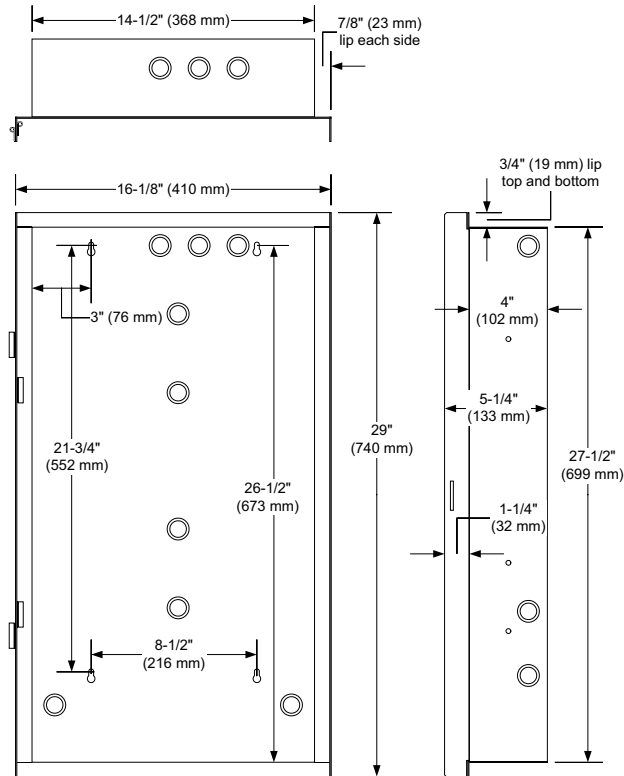

MR-2920 Back Box Dimensions

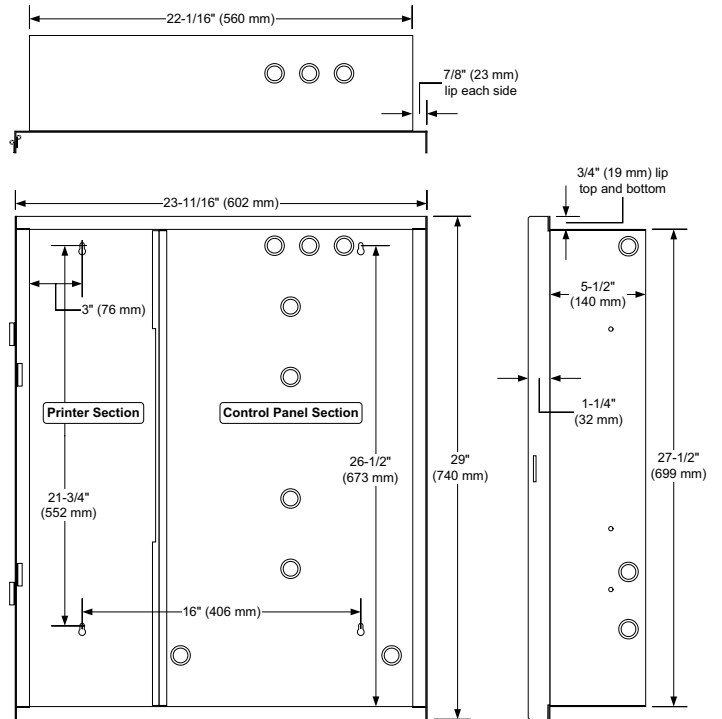

Exploded View, MR-2900 and MR-2920

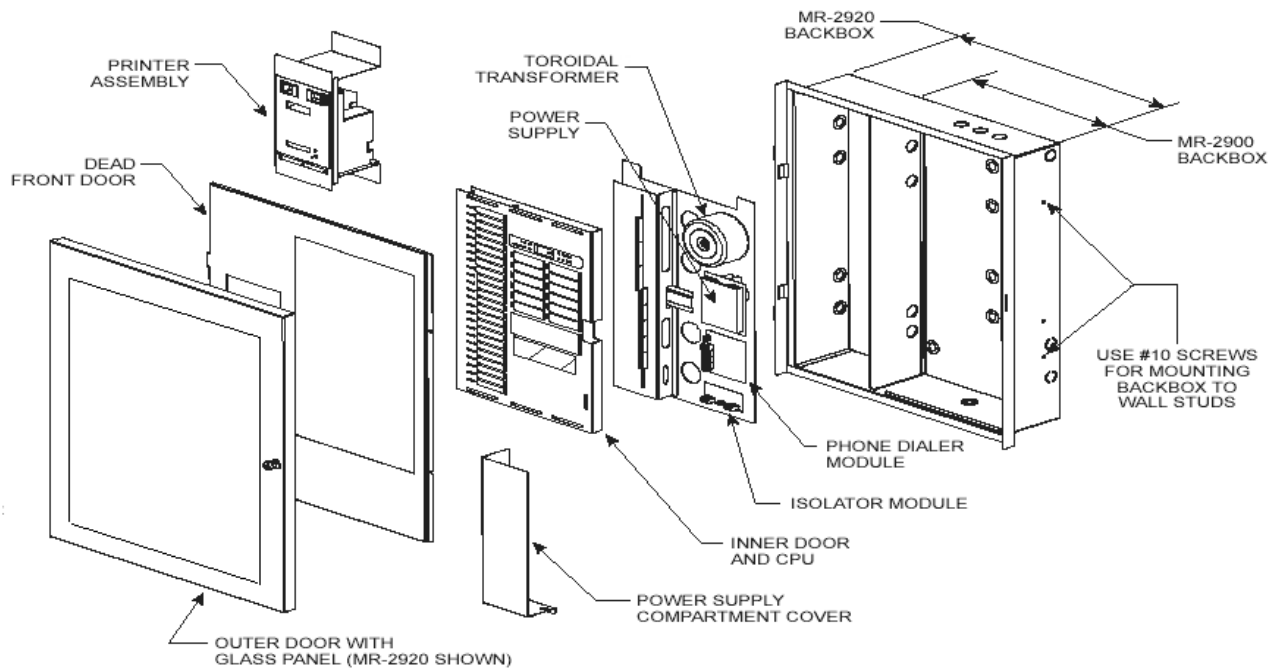

Ordering Information

Model	Description
MR-2900 Pre-Configured Kit	
MR-2900KR	Pre-configured MR-2900 Series Addressable System Kit that includes a red door and black backbox, inner door assembly, universal terminal board, power supply and is configurable for 120V or 240 operation. The Inner Door Assembly includes: <ul style="list-style-type: none"> • Eight Style 4 (Class B) or Four Style 7 (Class A) SLC Addressable Loops • Eight Style Y (Class B) Notification Appliance Circuits • 8MB Database Memory • MR2-7A Program
MR-2900KB	Pre-configured MR-2900 Series Addressable System Kit that includes a white door and black backbox, inner door assembly, universal terminal board, power supply and is configurable for 120V or 240 operation. The Inner Door Assembly includes: <ul style="list-style-type: none"> • Eight Style 4 (Class B) or Four Style 7 (Class A) SLC Addressable Loops • Eight Style Y (Class B) Notification Appliance Circuits • 8MB Database Memory • MR2-7A Program
MR-2900 / MR-2920 Custom Configured Panels	
Basic Panel (Specify Color and voltage option & MR2 Program)	
MR-2900	Basic MR-2900 Series FACP with black back box, outer door, dead front door, inner door assembly, terminal board, 8MB database memory and power supply.
MR-2920	Basic MR-2920 Series FACP with Integral Strip Printer, black back box, outer door, dead front door, inner door assembly, terminal board, 8MB database memory and power supply.
Color Option	
MR-2900-Red	Red Outer Front Door for MR-2900
MR-2900-Beige	White Outer Front Door for MR-2900
MR-2920-Red	Red Outer Front Door for MR-2920
MR-2920-Beige	White Outer Front Door for MR-2920
Voltage	
MR-2900-120V	120 VAC Operation
MR-2900-240V	240 VAC Operation
MR2 Program	
MR2-7	Basic program that uses a Database, Addressable or Conventional modules
MR2-7A	Use with MR-2109-3 Module for MR-2614, MR-2644, MR2900-DACT & MR2900-CITY
MR2-7B	Use with MR-2109-2 for SE-2000
MR2-7E	Use with MR-2109-4 for MV-2700
MR2-7G	Use with MR-2109-4 for MR-GRID-II & SE-8100

Model	Description
Adder Modules for MR-2900KR and Custom Configured Panels	
Addressable Loop Module (Max. 2 per panel)	
MR-2929	Addressable 8 Class B / 4 Class A Loop Module
Conventional Input Circuit Modules (Max. 3 per panel)	
MR-2928	Conventional Input Circuit Module (Class B (Style B) Contact Devices and Smoke Detectors)
MR-2938	Conventional Input Circuit Module (Class A (Style D) Contact Devices and Smoke Detectors)
NAC Style Y (Class A) Converter Module	
MR-2937	Eight Style Y (Class A) Converter Module
Network Module	
MR-2910	Network Communication Module, Both Ports Standard
MR-2910-R1	Network Communication Module, Port 1 RS-232, Port 2 Standard
MR-2910-R2	Network Communication Module, Port 2 RS-232, Port 1 Standard
MR-2910-R12	Network Communication Module, Both Ports RS-232
DACT/CITY Module	
MR-2900-DACT	Digital Communicator Module with Isolator Module
MR-2900-CITY	City Box/ RP Transmitter Module with Isolator Module
Note: The MR-2900-DACT or MR-2900-CITY modules REQUIRE the MR-2109-3 module in Port 3 (below).	
Port 3	
MR-2109-2	Opto-coupled Line Driver (Auto) for SE-2000, New Protocol, use MR2-7B Program (use MR2-7 program for Old Protocol)
MR-2109-3	Driver for MR-2614 & MR-2644 Annunciators and MR-900-DACT or MR-2900-CITY Module, MR2-7A Program
MR-2109-4	RS-232 Driver for MR-GRID-II (MR2-7G Program) or SE-8100 (MR2-7G Program) or MV-2700 (MR2-7E Program)
Optional Item	
MR-2900-PRT	Parallel Printer Interface extension cable
MR-2900/2920 Fiber Optic Network Converters	
MR-D1010-R1	RS-232 transceiver module to fiber, 24VDC, single channel
MR-D1010-R2	RS-232 transceiver module to fiber, 24VDC, dual channel

